

Technical data

6204LLU/5K

Single row deep groove ball bearings



Deep groove ball bearing, radial contact, pressed steel cage, contact seals on both sides

VISUAL (S)

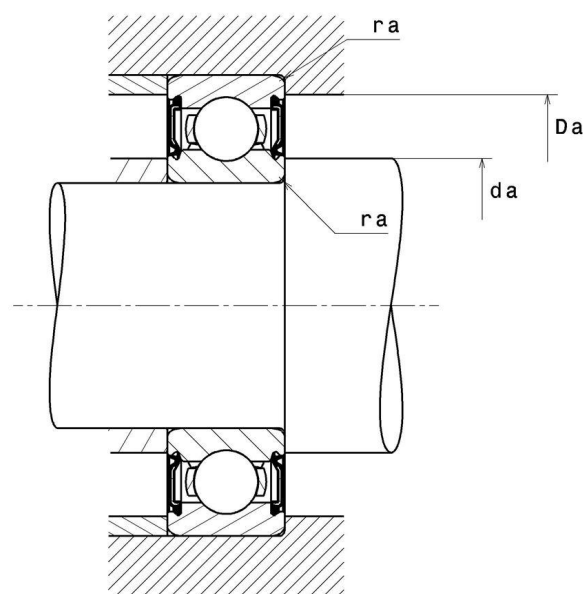

6204LLU/5K

Single row deep groove ball bearings

PRODUCT DEFINITION

Brand	NTN
d - Internal diameter	20 mm
D - External diameter	47 mm
B - Bearing/Inner ring width	14 mm
rs - Min fillet radius	1 mm
Radial clearance class	CN
Mass	0,106 kg

PRODUCT PERFORMANCE

C - Dynamic load	14,2 kN
C0 - Static load	6,65 kN
Cu - Fatigue limit load	0,505 kN
f0 - Coefficient	13.2
N lim - Grease lubrication limit speed	10000 tr/min
Tmin - Min operating temperature	-25 °C
Tmax - Max operating temperature	110 °C

ABUTMENT

da min - Min shoulder diameter IR	25 mm
da max - Max shoulder diameter IR	28 mm
Da max - Max shoulder diameter OR	42 mm
ra max - Max shaft & housing fillet radius	1 mm



NTN Europe

1 rue des Usines · BP 2017 · 74010 Annecy Cedex · France · Tel. +33 (0)4 50 65 30 00
 S.A. au capital de 322 639 919 € · RCS ANNECY B 325 821 072 · Id. Fiscale : FR 48 325 821 072
 SIRET 325 821 072 00015 · Code APE 2815 Z · Code NACE 28.15

INDUSTRY CALCUL FACTORS

Equivalent dynamic radial load

$P = X.F_r + Y.F_a$

$\frac{f_0 F_a}{C_0}$	e	Fa / Fr ≤ e		Fa / Fr > e	
		X	Y	X	Y
0.172	0.19	1	0	0.56	2.3
0.345	0.22				1.99
0.689	0.26				1.71
1.03	0.28				1.55
1.38	0.3				1.45
2.07	0.34				1.31
3.45	0.38				1.15
5.17	0.42				1.04
6.89	0.44				1

Equivalent static radial load

$P_0 = X_0.F_r + Y_0.F_a$

X_0	Y_0
0.6	0.5

For single or DT bearing arrangement :

If $P_0 < F_r$, then use $P_0 = F_r$

